



Installation Instructions For Vari-Fan Ceiling Fans

Toll free: 1 (877) 24-VOLTS
Web: nextekpower.com
Email: info@nextekpower.com



Installation Instructions For Vari-Fan Ceiling Fans

Installation Instructions For **Vari-Fan** Ceiling Fans
Vari-Fan Ceiling Fans DC powered fans designed
to operate on 12 or 24 vdc only!

Toll free: 1 (877) 24-VOLTS
Web: nextekpower.com
Email: info@nextekpower.com

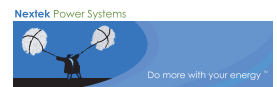

**WARRANTY:**

All fan bodies and fan motors are warranted against defect for one (1) year from time of sale. Please keep any dated invoices or sales receipts for proof of purchase.

DISCLAIMER:

All DC powered ceiling fan motors are rated for one (1) amp maximum input. All warranties on the motor and body part are voided if the power input to the motor exceeds one (1) amp.

PLEASE NOTE:

When operating an DC powered ceiling fan directly from a Photo Voltaic (PV) panel, without a battery in the circuit, be sure the output of the panel does not exceed 20 watts at 12 or 24Vdc. This will void your warranty.

IMPORTANT INFORMATION :

It is recommended that all Nextek Fanworks DC ceiling fans be used in conjunction with a reversible speed control 12/24V.

If using a photovoltaic you must use a Nextek reversible speed control 12/24V.

The Nextek DC ceiling fans can be operated above 24Vdc but not to exceed 48Vdc. 48Vdc can be special ordered. The 12/24V speed control is designed to work between 12 and 24V.

CAUTION: ⚠

1. Read entire instructions carefully before beginning installation.
2. To avoid possible electrical shock, be certain electricity is shut off at main panel before wiring.
3. All wiring must be in accordance with national and local electrical codes. If you are unfamiliar with wiring, you should use a qualified electrician.

WARNING:

1. To reduce the risk of fire or electrical shock, do not use a solid state speed control with this fan. Use Nextek controls only.
2. To reduce the risk of personal injury, do not bend the blade brackets when installing the brackets or cleaning the fan. Do not insert foreign objects in between rotating fan blades.
3. To reduce the risk of personal injury, install the fan only to the building structure according to these instructions, and use only the hardware supplied.

Step 1: Pre-Installation Instructions

- A. Select installation site. Check to see that in normal use no object can come in contact with the rotating fan blades. The mounting site should also meet the precautions listed in Step 3 below.
- B. Installation hardware is included for a standard drywall or plaster ceiling. You will need a 4" x 1-1/2" or a 4" x 1/2" outlet box and wire nuts (2) which can be purchased from any hardware store or electrical supply house.
- C. The fan blades must be mounted at least 7' above the floor. For maximum

MY FAN MAKES A RUBBING SOUND WHEN RUNNING:

Turn your fan off, when the blades have stopped turning, spin the fan with your hand, if you hear the rubbing sound, it is most likely that the fan's hub is rubbing against the motor housing.

Loosen the hub's set screw; remove the decorative knob covering the fan's motor shaft. Using a flat bladed screw driver, pry the safety push nut away from the hub (about 1/8 inch) Try spinning the fan again, if the rubbing sound is gone, then re-tighten the set screw and replace the decorative knob.

MY FANS BLADES SEEM TO GO UP AND DOWN AS THE FAN SPINS:

Turn fan off, gently rotate hub by hand, look for the high and low movement of the blades. Grab the hub at the high spot with one hand, with your other hand, grab the low spot, then "gently" push the low side of the hub up while pulling down on the high side. Spin the hub again and see if the up/down wobble is gone, if not, repeat the procedure until problem is fixed.



TROUBLE SHOOTING:

The following are tips that may help fix a problem that you are having with a Nextek Power Systems Fanworks DC powered ceiling fan.

FAN DOESN'T RUN:

Check all connections to make sure you have power, use a volt meter or multi tester to confirm that the voltage is correct. If fan still doesn't run, try connecting the fans leads directly to the battery (no switches or speed controls) If fan still won't run, please contact Nextek Power Systems Fanworks, not your dealer.

FAN MOTOR IS HOT TO THE TOUCH:

Turn off fan immediately, and contact Nextek Power Systems Fanworks.

FAN MAKES "CLICKING" NOISE:

The "clicking" noise is usually a bur on one or both brushes. First try reversing the fan (i.e.: make it run backwards) this can be done by reversing the polarity of the fans wires at the battery. If your fan has a speed control but no reversing switch, reverse the leads that run from the speed control to the fan. In either case, let the fan run at least 24 hours in reverse, then try running the fan in forward and see if the noise is gone.

The second option, if your fan is not too high up, is to take a broom handle and give a sharp upward rap to the decorative nut at the center of the fan hub. (Do this while the fan is running)

Please note: Fans in summer cottages or in places where the fan is not run for long periods of time are more prone to developing a bur on the brushes. Before starting fan, gently spin the blades by hand, and then turn on fan.

If problem persists, please contact Nextek Power Systems Fanworks.

MY FAN WOBBLER WHEN RUNNING:

Most fans mounted with a down rod will have a slight wobble (less than 1 inch from the center) depending on how long the down rod is.

All Nextek Power Systems Fanworks fans come from the factory with balanced blades and blade arms.

Make sure that the when the hub was placed on the fan shaft, that the flat on the shaft matched the flat on the hub's center hole.

Check that all the blade arms have the same pitch. (Lay them in line on a flat surface and check that all the blade arms lay at the same angle.) If the pitch on one of the blade arms is different, try twisting the arm until it matches the rest of the arms.

Most large hardware stores, Home Depot, Lowes, Ace, etc, that sell ceiling fans, have blade balancing kits. These are very inexpensive and have good instructions, if the above ideas don't work, pick up a kit and try it.



efficiency, they should not have any obstruction (walls, posts, etc.) within 24" of the blade tips. See Figure 1 for mounting distances.

Step 2: Inspection of Fan

- Unpack the fan carefully to avoid any damage to the components.
- Check for any shipping damage to the motor and the fan blades. If more than one fan is being installed, keep the matched and balanced fan blades in sets, as they were shipped. Should one of the fan blades become damaged during shipment, return all blades in the set for replacement.
- Check contents to be certain it contains a bag of parts.

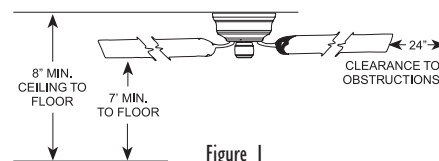

Figure 1

Step 3: Installation of Outlet Box and Rough-In Wiring

CAUTION: ⚠

Your ceiling fan with accessories can weigh up to 35 lbs. The following precautions must be taken for safety and to ensure that your fan is securely mounted to the ceiling.

- Be certain electricity is "off" at fuse panel when inspecting or repairing installation site.
- All wiring must meet local and national electrical codes.
- Do not mount directly to an unsupported ceiling or to an electrical outlet box. Mounting must support a 35 lb. fan with accessories.

- Secure metallic outlet box 4" x 1-1/2" or 4" x 1/2" deep to 2 x 4 cross brace between two ceiling joists as shown in Figure 2. The outlet box must be recessed into the ceiling by 1/16" minimum. Secure the outlet box to the cross brace by drilling (2) pilot holes no larger than the minor diameter of the wood screws (5/64") and use two #8 x 1-1/2" wood screws and washers. Use the innermost holes for securing the box. Orient the box so the outermost holes will be used in Step 4B.

CAUTION: ⚠

Do not use a lubricant on screws.

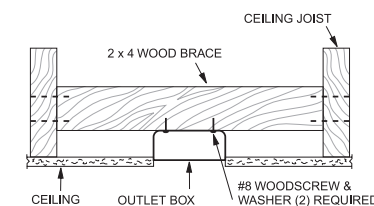

Figure 2

- Bring electrical cable into the outlet box and attach with an approved connector. Make certain that wiring meets all national and local electrical codes. Wire leads should extend at least 6" beyond outlet box for ease in making connections. See Figure 3.

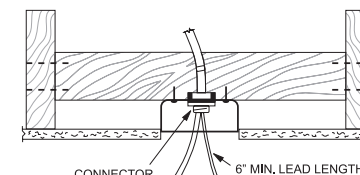

Figure 3



Step 4.1: Fan Assembly Close Mount Version

Follow the instructions below for installation of close mount ceiling fan.

1. Remove mounting bracket (#1) from mounting cone.(#3) Leave the screws in the bracket that match up with the open hole on each side of mounting cone.



2. Attach mounting bracket to junction box or directly to ceiling using screws taped to mounting bracket. Lead wires through center hole in bracket.

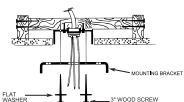

3. Remove retaining knob (#18) and clip (#17) from bag found inside hub (#14).



4. Align the hub (#14) with the motor shaft (#13). Align the flat side of the motor shaft to the Allen Screw hole. Push hub onto shaft until 3/8" (1cm) of the shaft protrudes from the hub. Tighten set screw using Allan Wrench included with fan.

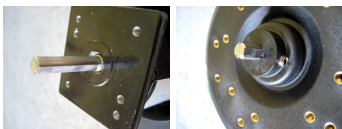

5. Push retaining clip (#17) onto motor shaft unit until it is firmly against the hub.



6. Push retaining knob (#18) onto motor shaft until it is firmly against the hub.



7. Lift completed motor and hub assembly to mounting bracket on ceiling, and slip one hole on side of mounting cone over hook on bracket.

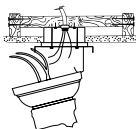

8. With motor and hub assembly hanging from hook, connect fan wires to the house wires using the three (3) wire nuts included with fan:

White = positive
Black = negative
Green = ground

- ▲ (Please Note: Fan should only be operated in a counter clockwise direction, connect white wire of fan to the negative power wire, and the black wire of fan to the positive power wire. The green wire should be connected to the ground wire on the mounting bracket.)



Step 5: Painting

1. The Vari-Fan can be easily painted using an acrylic based spray paint.
2. Dark colors (red, blue, green, or brown) should take only one coat of paint.
3. Light colors (white, yellow, or pastels) may take two or more coats. Follow the instructions on the can of spray paint for applying multiple coats.
4. To disassemble the Vari-Fan, look at the exploded drawing in Parts Information. This will show you how the fan comes apart. Be sure to use a bag or cup for storing screws and pins.
5. There are four (4) parts that are normally painted: the mounting cone (#03), the down rod (#07), motor housing (#12), and the hub (#14). Be sure to remove the set screw from the hub.
6. The receptacle (#11) and the pivot ball (#5) are normally left black.
7. Using soft wire, make 4 long "S" hooks so each piece may be hung while painting and drying.
8. Follow the instructions on your can of spray paint for proper spraying technique and drying times required.
9. Once the painted parts are dry, you may re-assemble the fan following the diagram in Parts Information.



Parts Information

- 01 1 x Mounting Bracket
- 02. 4 x 10/32 x 3/8 P.H. Phillips
- 03 1 x Mounting cone
- 04 4 x 10/32 x 3/8" P.H. Phillips
- 05 1 x Pivot Ball
- 06 1 x Retaining Pin
- 07 1 x Down Rod
- 08 1 x Pin & Clip
- 09 1 x 10/32 x 3/8 P.H. Phillips
- 10 4 x 8/32 x 1/2 F.H. Phillips
- 11 1 x Receptacle
- 12 1 x Motor Housing
- 13 1 x Fan Motor
- 14 1 x Hub
- 15 1 x 1/4 /20 x 5/16 Set Screw
- 16 10 x 10/32 x 3/8 P.H. Phillips
- 17 1 x Retaining Clip
- 18 1 x Retaining Knob
- 19 15 x 10/32 x 1/2 P.H. Phillips
- 20 15 x Washers
- 21 5 x Fan Blades
- 22 5 x Blade Arms

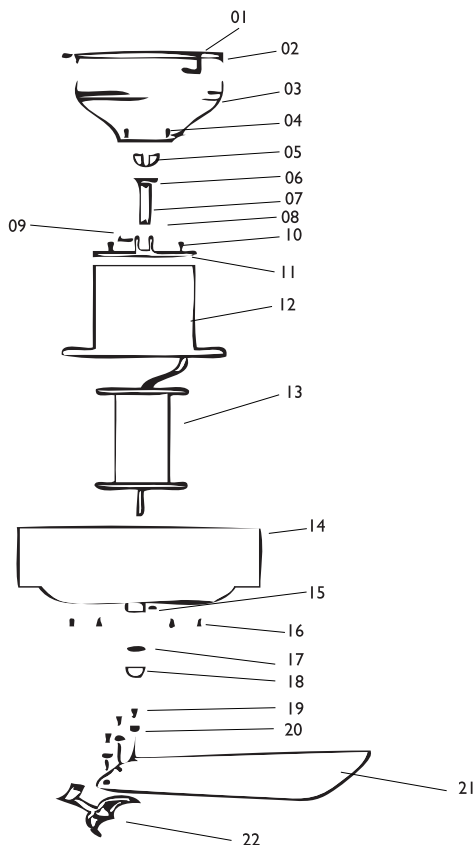

9. After wires are connected, remove fan from hook, and slip mounting cone over mounting bracket. Align the open holes of cone with the two screws, and rotate until cone will stay in place. Then replace the other two screws in cone and tighten all four screws firmly.



10. Turn on power, and check that motor shaft is turning in a counter clockwise direction.
Turn power off.
11. Assemble blade arm (#22) and fan blades (#21) using the 15 screws and washers (#20) that are in bag with blade arms.

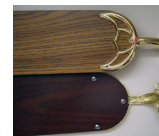

12. Once the blades and arms are assembled, attach the assemblies to the hub using the bag of 10 screws (#16). The inside hole pattern on the hub is for four (4) blades.
The outside hole pattern on the hub is for five (5) blades.
13. Turn on your fan

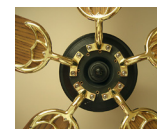
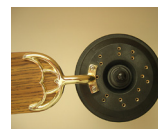



Step 4.2: Fan Assembly Down Rod Version

Follow the instructions below for installation of down rod ceiling fan.

1. Remove mounting bracket (#1) from mounting cone. (#3) Leave the screws in the bracket that match up with the open hole on each side of mounting cone.



2. Attach mounting bracket to junction box or directly to ceiling using screws taped to mounting bracket. Lead wires through center hole in bracket.

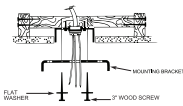

3. Remove the four screws (#04) holding the mounting cone (#3) to top of fan. Remove cone from top of fan.



4. Put down rod (#07) through mount cone (pivot ball (#05) end of rod remains in cone).
5. Feed wires from receptacle through bottom of down rod (#07) and out through the pivot ball end.

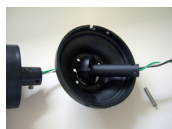

6. Remove retaining pin and retaining clip (#08) from receptacle.
7. Slip down rod into receptacle, and align holes of rod with hole in receptacle.
8. Re-insert pin through receptacle/down rod assembly and attach clip.
9. Tighten screw on side of receptacle.

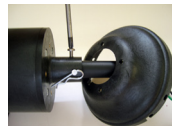

10. Align the hub (#14) with the motor shaft (#13). Align the flat side of the motor shaft to the Allen Screw hole. Push hub onto shaft until 3/8" (1cm) of the shaft protrudes from the hub. Tighten set screw using Allan Wrench included with fan.



11. Push retaining clip (#17) onto motor shaft unit until it is firmly against the hub.



12. Push retaining knob (#18) onto motor shaft until it is firmly against the hub.



13. Lift completed motor and hub assembly to mounting bracket on ceiling, and slip one hole on side of mounting cone over hook on bracket.

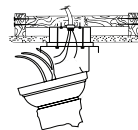

14. With motor and hub assembly hanging from hook, connect fan wires to the house wires using the three (3) wire nuts included with fan.

White = positive
Black = negative
Green = ground

- ▲ (Please Note: Fan should only be operated in a counter clockwise direction, connect white wire of fan to the negative power wire, and the black wire of fan to the positive power wire. The green wire should be connected to the ground wire on the mounting bracket.)

15. After wires are connected, remove fan from hook, and slip mounting cone over mounting bracket. Align the open holes of cone with the two screws, and rotate until cone will stay in place. Then replace the other two screws in cone and tighten all four screws firmly.



16. Turn on power, and check that motor shaft is turning in a counter clockwise direction.

Turn power off.

17. Assemble blade arm (#22) and fan blades (#21) using the 15 screws and washers (#20) that are in bag with blade arms.



18. Once the blades and arms are assembled, attach the assemblies to the hub using the bag of 10 screws (#16). The inside hole pattern on the hub is for four (4) blades. The outside hole pattern on the hub is for five (5) blades.

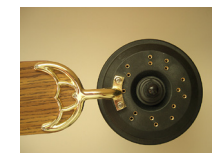

19. Turn on your fan

